

SIDEBAND SLICER

INSTRUCTION MANUAL

III MX

This unit is licensed under one or
both of the following U.S. Patents:

No. 2,566,876

No. 2,611,036

M222

CENTRAL ELECTRONICS, INCORPORATED
1247 W. BELMONT AVENUE
CHICAGO 13, ILLINOIS

FACTORY TECHNICAL ASSISTANCE

If it becomes necessary to write the factory for technical assistance regarding the operation, maintenance or repair of Central Electronics equipment, we request that the following data be furnished:

- A. Date of purchase, Serial Number, factory wired unit or kit, from whom purchased.
- B. Complete description of problem including position of all switches and potentiometers.
- C. The following information, where applicable:
 1. Method of connection.
 2. Detailed description of all accessories used in conjunction with the equipment, such as type of VFO, relays, TR switches, phone patches, low pass filters, antenna tuners, antenna feed method, SWR indicators, linear amplifier, etc.
 3. Various frequencies or bands which unusual effects are observed; state whether effects occur with VFO or crystal operation, or both. This information can often assist us in rapidly localizing the trouble.
 4. AC line voltage at full load.
 5. Meter readings on all positions of meter switch.
 6. Test equipment you have available.

FACTORY SERVICE

Central Electronics maintains a Service Department for the repair and modernization of all CE equipment. Please DO NOT return equipment without authorization! When shipping units (in their original cartons if possible) be sure to pack any plug-in units (such as the PS-1 and QT-1) separately in the carton and ship prepaid. If the original shipping container is no longer available, we can ship another at your request. Our service charge is based on time and material used. Be sure to furnish full details regarding the work to be done.

CENTRAL ELECTRONICS, INCORPORATED
1247 WEST BELMONT AVE.
CHICAGO 13, ILLINOIS

October 11, 1960

MODEL A SLICER ONLY

CONNECTION TO THE RECEIVER

Phono type jacks and plugs are supplied with the Sideband Slicer. They may be mounted on the rear of the receiver to interlock the connecting cables if a professional appearance is desired, but it is not essential to the proper operation of the unit.

The Sideband Slicer replaces the detector normally used in your receiver. It should not be connected in parallel with the diode 2nd detector because the distortion produced by rectification in the diode will result in degraded sideband suppression.

METHOD A - Without AP-1 Adapter

Disconnect the diode plates from the secondary winding of the last IF transformer or remove the detector tube. Connect one side of the 15 mfd capacitor supplied with the unit to the IF winding. The coaxial cable should be connected between the 15 mfd capacitor and the IF IN jack on the rear of the Sideband Slicer. The cable shield should be soldered to the nearest ground.

The lead from the second detector AF output to the "Hot" end of the AF gain control should be opened. A shielded lead should be connected between the hot end of the gain control and the AF OUT jack on the rear of the Sideband Slicer. The cable shield should be soldered to the nearest ground.

This method disconnects the normal second detector entirely and as a result the AVC, S Meter and Noise Limiter will not function on the average receiver. With the sideband selector switch in the NORMAL position the Sideband Slicer will function as a conventional diode detector, but without AVC or noise silencer action. If it is desired to retain these receiver functions, the use of Model AP-1 plug-in adapter is recommended. Then the NORMAL position of the sideband selector switch will disconnect the slicer entirely, returning the receiver to conventional operation. See METHOD B.

Receivers with separate amplified AVC systems and IF type noise silencers will retain these functions. The AP-1 adapter will not be required. The Sideband Slicer can be connected as outlined in A above.

METHOD B - With AP-1 Adapter

The Model AP-1 adapter is essentially an outboard IF stage that duplicates the last IF stage in the receiver. It plugs into the rear of the Sideband Slicer. The coaxial cable from the AP-1 is coupled to the control grid of the last IF amplifier tube through the 15 mfd capacitor supplied. The cable shield is soldered to the nearest ground.

The lead from the second detector AF output to the "Hot" end of the AF Gain control should be opened. A shielded lead should be connected between the hot end of the gain control and the VOL CONT jack on the rear of the Sideband Slicer. Another shielded lead should be connected between the second detector AF output and the REC DET jack on the rear of the Slicer. The cable shields should be soldered to the nearest ground. The selector switch on the Slicer connects these two leads together in the NORMAL position, thereby returning the receiver to its original circuit.

For a technical discussion of the "Phasing" method of exalted carrier demodulation please refer to QST for April '48, page 19; June '48, page 11; and July '48, page 11.

SIMPLIFIED RECEIVER CONNECTION DIAGRAM FOR MODEL A ONLY

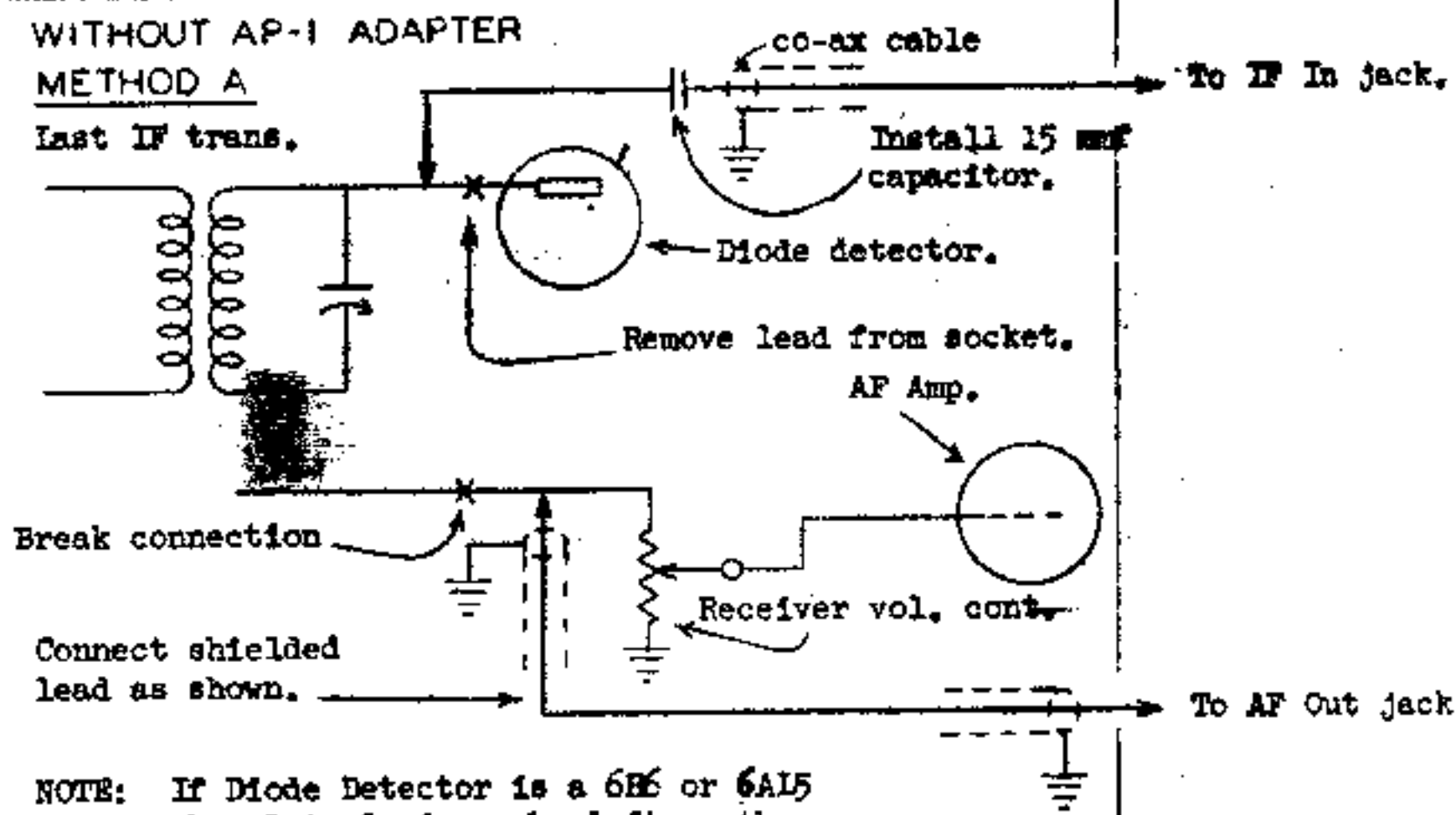
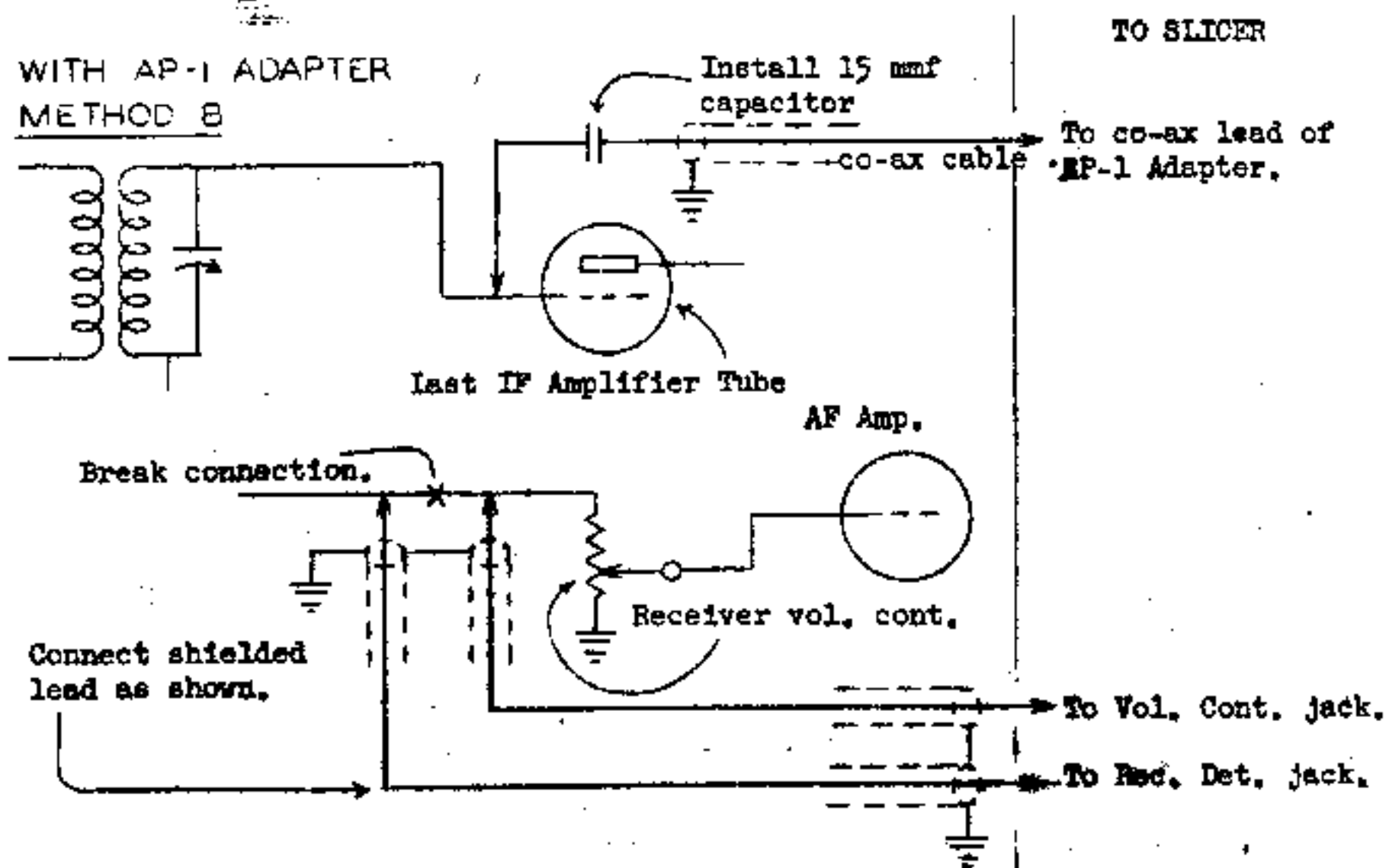

NOTE: If Diode Detector is a 6BE6 or 6AL5 the plate lead may be left on the socket and the tube removed.

MODEL B SLICER

ONLY

CONNECTION TO THE RECEIVER

Phone jacks and plugs are supplied with the Sideband Slicer. They may be mounted on the rear of the receiver to interlock the connecting cables if a professional appearance is desired, but it is not essential to the proper operation of the unit.

The Sideband Slicer replaces the detector normally used in your receiver. It should never be connected in parallel with the primary or secondary of a transformer that feeds a diode rectifier, as the rectification will result in distortion.

METHOD C - (See top of Page 6)

This method removes the Model B Slicer and Q Multiplier entirely in the NORMAL position of the selector switch.

Connect one end of a 15 mfd. capacitor to the grid of the last IF stage and the other end to the center conductor of the coax cable. Ground the outer conductor to the nearest convenient spot. These leads should be made as short as possible and kept close to the chassis to prevent IF regeneration. The lead from the second detector output to the "hot" end of the AF gain control should be opened. A shielded lead should be connected between the hot end of the gain control and the VOL CONT jack on the rear of the Slicer. Another shielded lead should be connected between the second detector AF output and the REC DET jack on the rear of the Slicer. Another shielded lead should be connected between the second detector AF output and the REC DET jack on the rear of the Slicer. The cable shields should be soldered to the nearest ground. The selector switch on the Slicer connects these two leads together in the NORMAL position, thereby returning the receiver to its original circuit.

METHOD D

This method allows the "Q" Multiplier to be used in the NORMAL position. The 6AL6 in the Slicer now functions as a conventional detector. In the NORMAL position, only series or shunt audio type of noise limiters will remain operative. Limiters that operate with the receiver's AVC will not be effective.

Connect one end of a 15 mfd. capacitor to the grid of the last IF stage and the other end to the center conductor of the coax cable. Ground the outer conductor to the nearest convenient spot. These leads should be made as short as possible and kept close to the chassis, to prevent IF regeneration. The lead from the second detector AF output to the "hot" end of the AF gain control should be opened. A shielded lead should be

~~connect~~ between the hot end of the gain control and the AF out jack on the rear of the Slicer.

If you experience a loss in signal gain when using the Slicer, the 15 mfd. coupling capacitor (which is installed in the receiver) should be increased to 50 mfd., or even 100 mfd. Whenever the value of this capacitor is changed, the IF transformer to which it is attached must be re-peaked. When necessary, it is possible to obtain a slight increase in gain by removing C16, the 500 mfd. capacitor on the 13 terminal strip, near the 6AL5 tube in the Slicer. The IF transformer on the "Q" Multiplier chassis must then be re-peaked.

SIMPLIFIED RECEIVER CONNECTION DIAGRAM FOR MODEL B SLICER ONLY

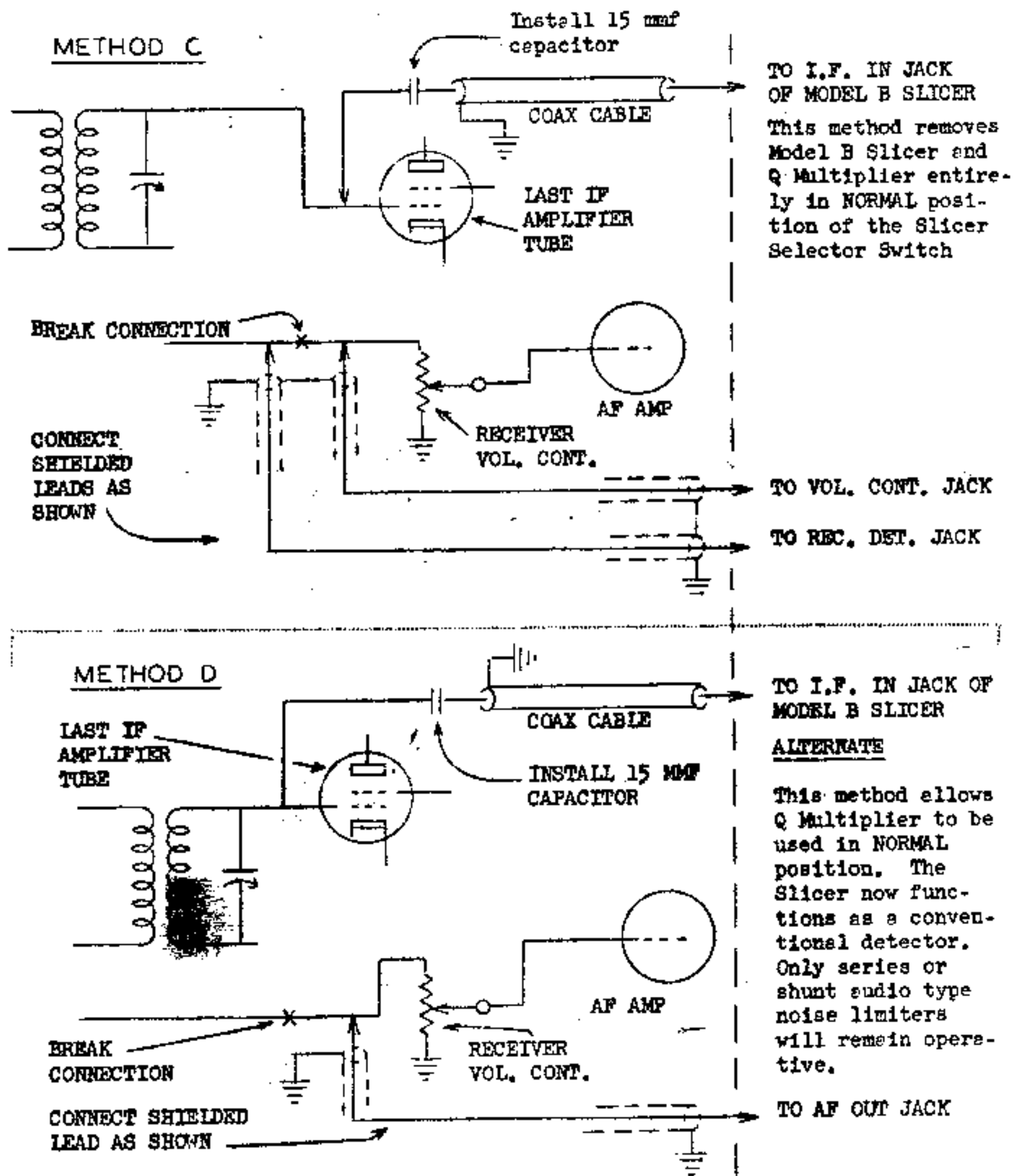

CONNECTING THE MODEL B SLICER WITH THE AP-3 CABLE (METHOD E)

For those who want the Q Multiplier to remain connected in the receiver NORMAL condition, the AP-1 Adapter and the AP-3 Cable must be used.

It will be necessary to solder the AP-3 coax cable (the one with the green dot) in parallel with the AP-1 input coax cable as shown on the bottom of drawing M142. Be sure to leave sufficient slack in this green cable so that the AP-1 may be removed from the socket.

The method of connection and details of the cable, are shown on the following three pages.

10-28-55
120MX AP-3 Cable
115MX Q Multiplier
111MX SS

AP-3 Cable Page 1
AQ Mult Page 8A
SS Page 6A

CENTRAL ELECTRONICS, INC.
 MODEL B SLICER CONNECTION WITH AP-3 CABLE

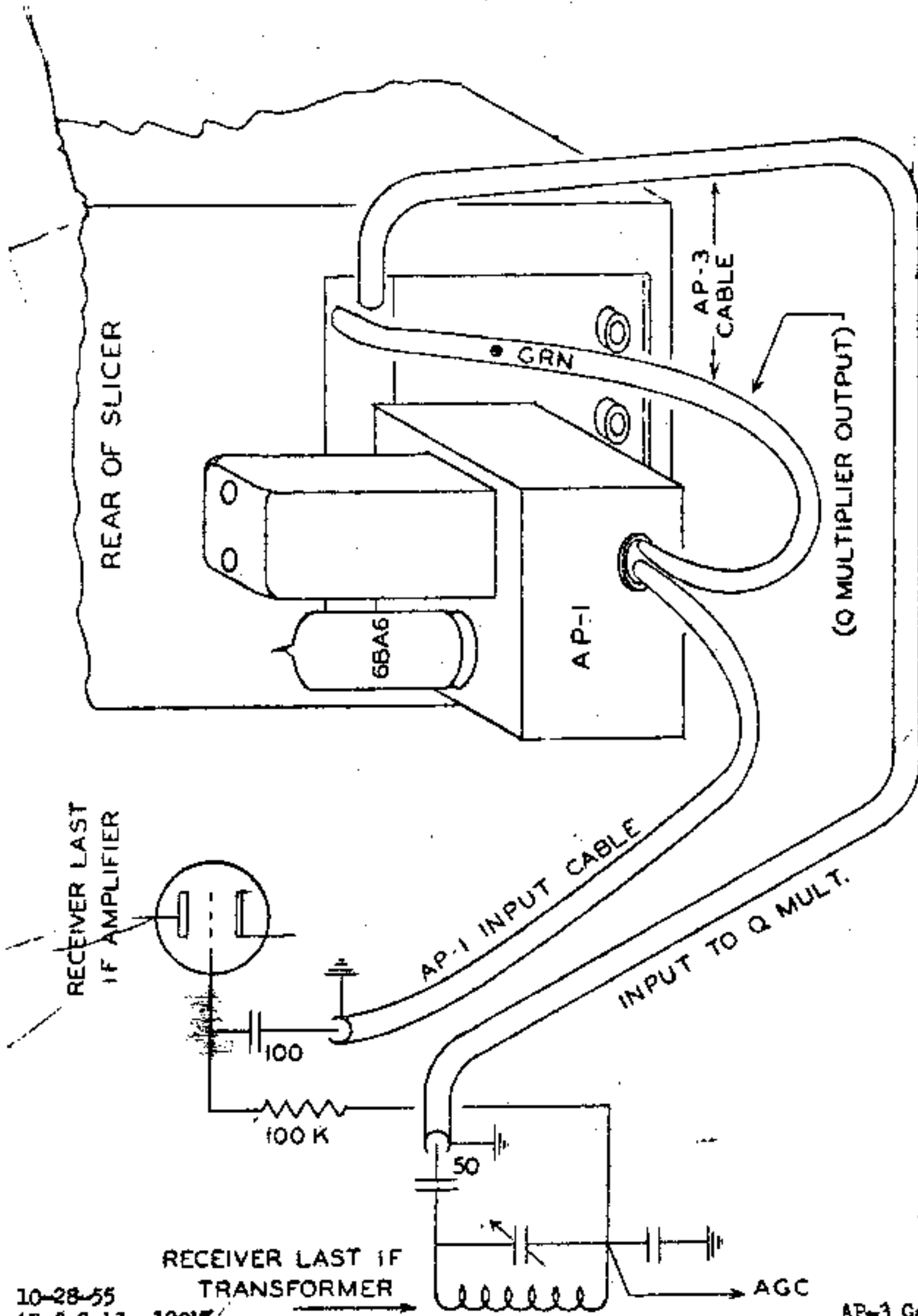

120 MX
 115 MX
 111 MX
 M141

10-28-55
 AP-3 Cable 120MX
 115 MXQ Mult.
 111 MX SS

AP-3 Cable Page 2
 AQ Mult Page 8B
 SS Page 6B

CONNECTING THE AP-3 CABLE TO THE RECEIVER

CENTRAL ELECTRONICS, INC.

MOUNTING THE AP-3 BRACKET
TO TOP OF OSCILLATOR CAN ON SLICER

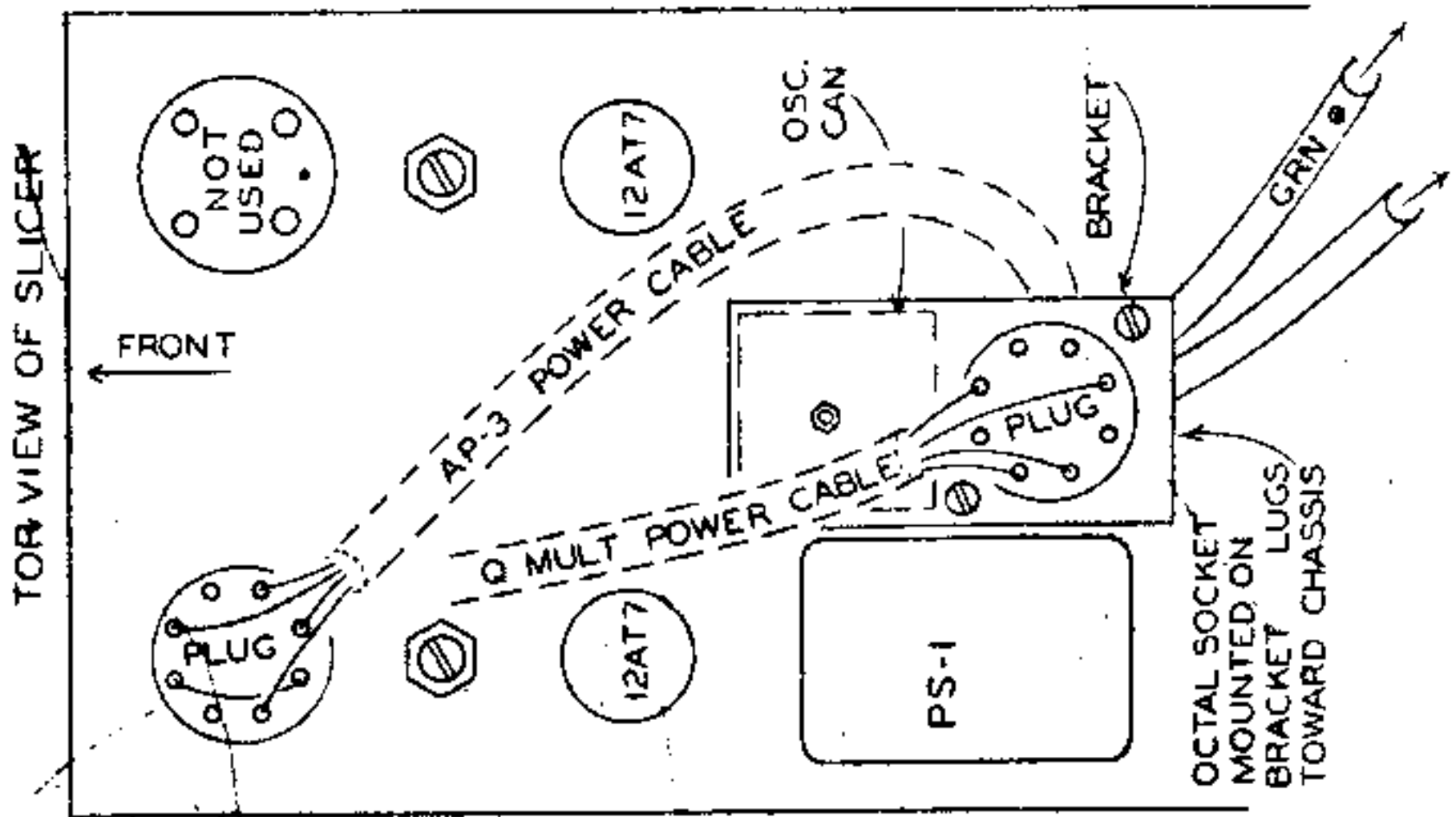

AP-1 CONNECTION

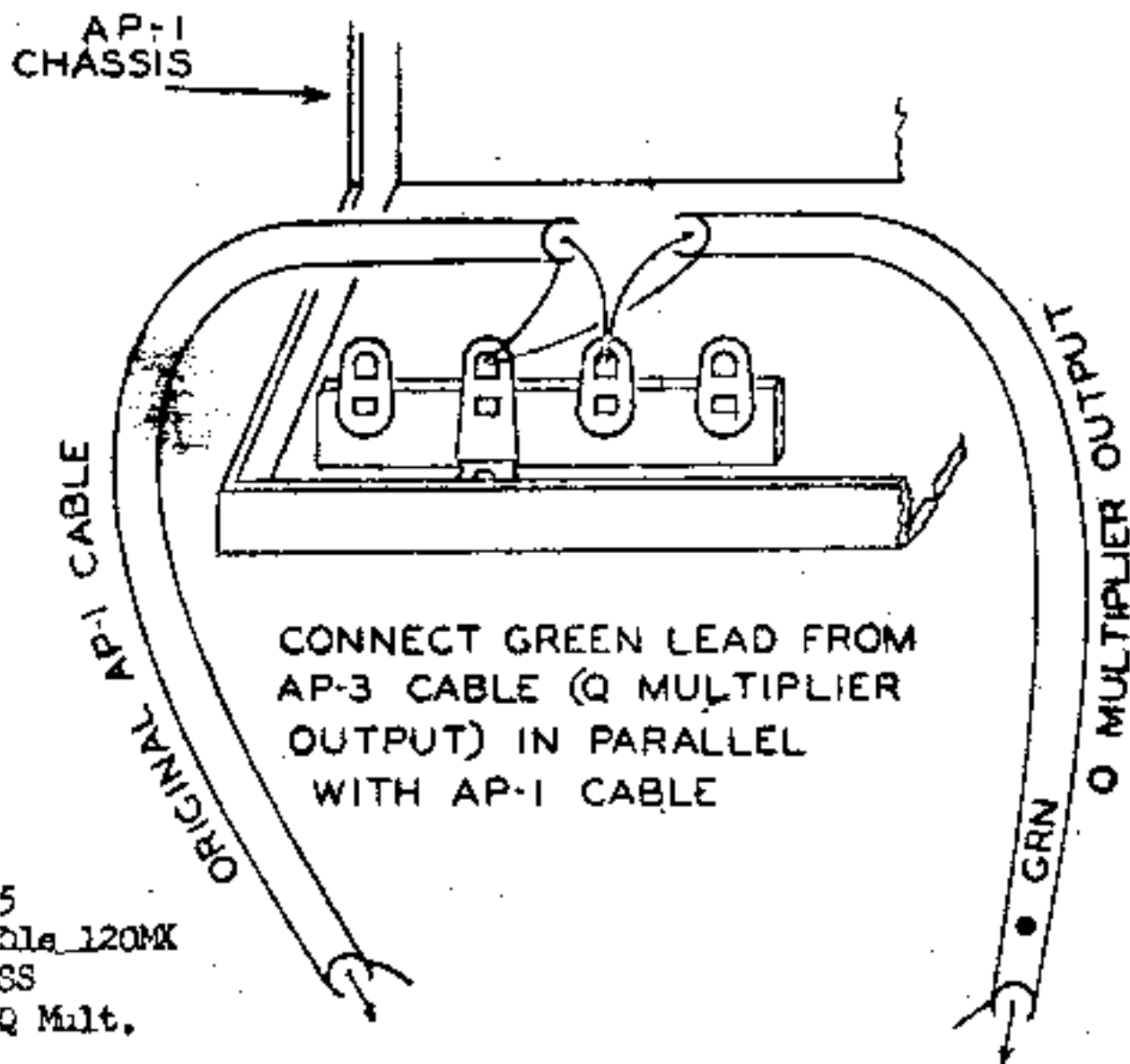

120MX
115MX
111MX
M142

10-28-55
AP-3 Cable 120MX
111MX SS
115MX Q Mult.

AP-3 Cable Page 3
SS Page 6C
A Q Mult Page 8C

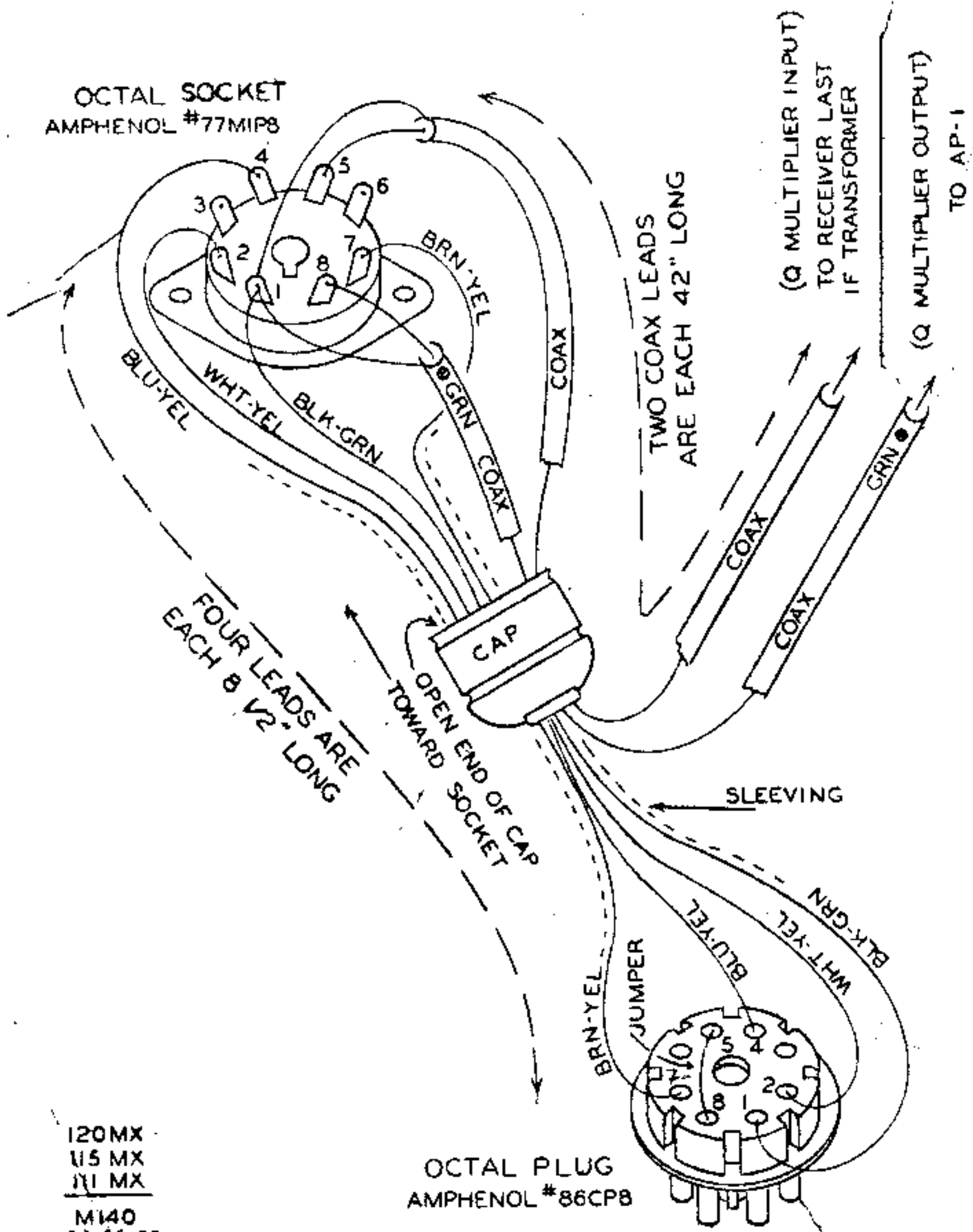

OCTAL SOCKET
AMPHENOL #77MIP8

4
5
6
3
2
1
8
7

BRN-YEL
BLU-YEL
WHT-YEL
BLK-GRN
GRN
COAX

FOUR LEADS ARE EACH 8 1/2" LONG

OPEN END OF CAP TOWARD SOCKET

TWO COAX LEADS ARE EACH 42" LONG

(Q MULTIPLIER INPUT)
TO RECEIVER LAST
IF TRANSFORMER

(Q MULTIPLIER OUTPUT)
TO AP-1

SLEEVING

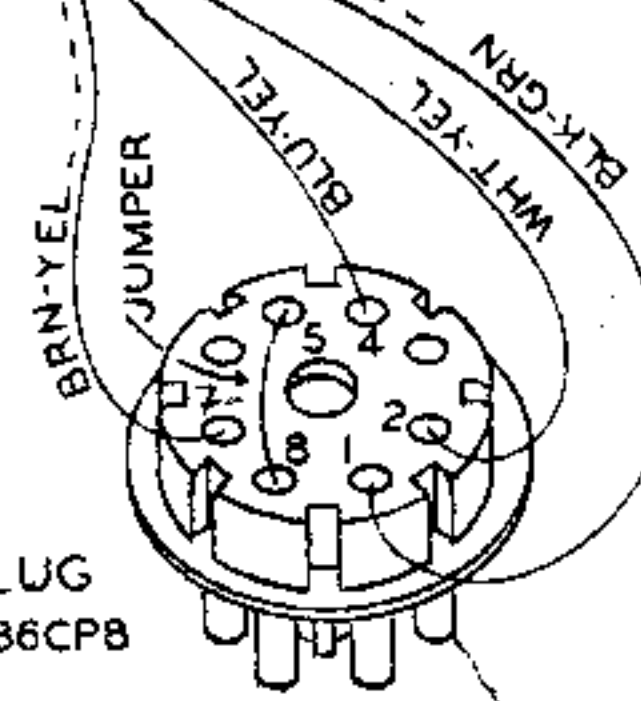

OCTAL PLUG
AMPHENOL #86CP8

- 120MX
- 115 MX
- 111 MX
- M140
- 10-28-55
- AP-3 Ca 11a 120MX
- 111MX SS
- 115MX Q Mult.

DETAILS OF
AP-3 CABLE

SUGGESTED METHOD FOR CONNECTING THE SIDEBAND SLICER TO A 75A-2 RECEIVER

Locate pin #1 of V7 (6BA6) last IF amplifier. There is an empty lug on the terminal strip nearby. Install the 15 mmf mica capacitor supplied with the Sideband Slicer between this empty terminal and Pin #1 on V7. Install a piece of coax cable between the 15 mmf capacitor and Pin #6 on the FM adapter socket. Connect the cable shield at both ends to the nearest convenient ground.

Locate V-10, the 6AL5 noise limiter. Unsolder the shielded lead on Pin #1, extend its length with another shielded lead and solder to pin #1 on the FM adapter socket. Add another shielded lead from Pin #1 of the 6AL5 socket to pin #3 on the FM adapter socket. Connect the cable shield at both ends to the nearest convenient ground.

This results in the opening of the audio lead from the 6AL5 noise limiter to the AM position on the CW-AM-FM switch and inserting in series two shielded leads which run to the slicer via the FM adapter socket.

The slicer is then connected as follows:

Pin #1	Vol. Cont.
Pin #3	Rec. Det.
Pin #5	Ground (Shields of all leads)
Pin #6	The coax lead from the AP-1 adapter on Model A, or coax lead to "IF IN" jack on Model B

To return the receiver to normal operation when the FM adapter is inserted it is only necessary to jumper Pins #1 and #3 on the FM adapter plug. It is then possible to operate with either the FM adapter or the Sideband Slicer without making any additional changes.

REVERSING THE SIDEBAND SELECTOR SWITCH FOR USE WITH COLLINS RECEIVERS

MODELS 75A1 AND 75A2 ONLY

Due to the method of double conversion employed in these receivers, the SB1 and SB2 positions will be reversed in relation to the switch on the Multiphase Exciters. To reverse the sideband positions on the Slicer the green-white and green-orange leads should be reversed on switch S2(B). After this change has been made, Pot. 2 must be used for adjusting the null when the switch is in SB1 position and Pot. 1 used when the switch is in SB2 position.

USING THE SIDEBAND SLICER WITH A MECHANICAL
OR LATTICE FILTER HAVING A 3KC PASS BAND

The former alignment procedure consisted of adjusting the exalted carrier oscillator to the center of the IF pass band. In this way equal fidelity was obtained in each sideband. Since the advent of the 3KC IF filter, it is apparent that using this method would result in a response of only 1500 cycles in each sideband. It is therefore necessary to adjust the oscillator in the slicer to the edges of the pass band.

A section of the main selector switch and trimmer C1A has been devoted to changing the oscillator frequency. To use this frequency changing feature it is necessary to install a jumper lead from terminal 4 of switch section D (Sideband 1 Position) on the wafer nearest to the front panel, to the 15 mfd capacitor. Also another jumper from wiper "D" to term. #4 of the 13 term. strip.

When the sideband selector switch is in SIDEBAND 2, C1A is out of the circuit. Adjust C1 to the high frequency edge of the IF filter. When the sideband selector switch is in SIDEBAND 1, trimmer C1A is switched in parallel with the main oscillator capacitor C1. This lowers the frequency of the oscillator. C1A should be adjusted to the low frequency edge of the IF filter.

It may be necessary to change the C1 stator jumper from SIDEBAND 1 to SIDEBAND 2 switch position, depending on the receiver design.

It is necessary to retune the receiver dial approximately 3 KC each time the sidebands are switched.

If switchable upper and lower sideband filters are used, this frequency changing feature should not be used. Align the Slicer to the center of the two filters.

SETTING THE SLICER OSCILLATOR FOR USE WITH THE 75A3 RECEIVER

(Follow alignment on Page 14 first)

1. The Slicer should be wired so that C1A is in parallel with C1 in the Sideband 1 position.
2. Set the Slicer to Normal.
3. Turn the receiver BFO on by turning switch to CW and set the BFO pointer about $3/16$ " beyond the -1 KC mark. This is the position where you normally adjust for lower sideband reception.
4. Leave the receiver in this position and set the Slicer to BFO position. Tune the Slicer oscillator capacitor C1 (the frequency control) to zero beat with the receiver BFO.
5. Now move the receiver BFO pointer to about $3/16$ " beyond the -1 KC mark, where you normally receive upper sideband transmission. Set the Slicer to Sideband 1. Adjust the small Slicer trimmer C1A (almost completely open) for zero beat. Turn off the BFO in the receiver and use the Slicer.

REVERSING THE SIDEBAND SELECTOR SWITCH FOR
COLLINS MODEL 75A-3 RECEIVER

When reversing the Sideband Selector Switch and oscillator frequency changing feature with the 75A3, it will be necessary to change the lead from Switch section D terminal #4 to terminal #2.

The green-white and green-orange leads must be reversed, as described on the bottom of page 7. Now the green-white will be on switch section B terminal #4, and the green-orange on terminal #2.

When adjusting the frequency of the oscillator with C1A, as instructed in number 5 on page 8, set the selector switch to Sideband 2, instead of Sideband 1.

SUGGESTED METHOD FOR CONNECTING A SIDEBAND SLICER TO HRO 50-T

A 5/32" hole will be found in the chassis next to the last IF tube (6K7). Remove the first six inches of shielding from a piece of 52 ohm coax. The center conductor of the coax and its polyethylene covering will now pass through this hole and the shielding can be grounded at the 6K7 socket saddle. A sheet metal screw is removed from the last IF can near the top of the 6K7 and a single lug insulated terminal strip is placed under it. The center conductor of the coax should reach this lug and it is soldered to it along with one end of the 15 mmf capacitor supplied with the Sideband Slicer. The other end of the capacitor is soldered to the grid cap of the 6K7. (Allow the grid lead that goes into the can to remain intact.)

Under the chassis again, the other end of the coax is run through a grommet in the chassis separator and then to the Selecto-ject socket where it is connected to Pin #4. The shield is connected to Pin #6 which is ground.

The audio circuit of the receiver is already brought out to the SOJ socket, therefore the wiring in the receiver is completed. The output of the receiver detector is on Pin #1 and the volume control connection is on Pin #5.

An octal plug must be obtained. If one is not available, the jumper plug that is supplied with the receiver may be used.

The Slicer is then connected as follows:

Pin #1	Rec. Det.
Pin #5	Vol. Cont.
Pin #6	Ground (shields of all leads)
Pin #4	The coax lead from the AP-1 adapter or "IF IN" jack of Model B

With this method, either the Sideband Slicer or the Selecto-ject may be used with the receiver without any additional changes.

CONNECTION TO THE HRO-60

The HRO-60 can be connected in the same manner, except that in this model the 15 mmf. capacitor should go under the chassis to 6SG7 V8, pin #4, instead of the 6K7 grid.

INSTALLATION TO SX-71 RECEIVER
MODEL A WITH AP-1 ADAPTER OR MODEL B

CAUTION: Do not lay SX-71 chassis upside down as this is almost certain to result in a broken slug in one of the IF transformers.

Install one phono jack between PHONO jack of set and S Meter adjustment. See drawing.

Install 2 phono jacks, one above the other, at left of receiver PHONO jack, between PHONO jack and tuner housing. (See drawing)

Install 15 mfd. capacitor at pin 4, 6SH7 socket (see tube layout in Instruction Manual supplied with receiver). Do not remove any wires from this lug.

Run R.F. cable from first phono jack installed (next to S meter) to 15 mfd just installed. Mark this jack "IF".

Route this RF cable alongside end of tuner housing and ground both ends of shield.

Find the end of a shielded pair (red and black wires in same shield) which runs from volume control to RECEPTION switch. See drawing. This shield is grounded and the wires come out near the 6SC7 socket. Red wire goes to bottom of front deck of this switch and black wire goes to top of front deck of this switch. Break the black wire. Connect an audio shielded cable (single conductor in shield) to this black wire coming from the shield from volume control and run it to bottom phono jack not yet connected. Mark this jack VOL. CONT. (See drawing) Connect an audio shielded cable to the end of black wire coming from RECEPTION switch and run it to top phono jack and mark it DET. (See drawing) Route these leads as shown in drawing and secure them by bonding to chassis at several points. Be sure these leads are secured so that shielding cannot touch any connections in the receiver if vibration should move them slightly.

FRONT ↓

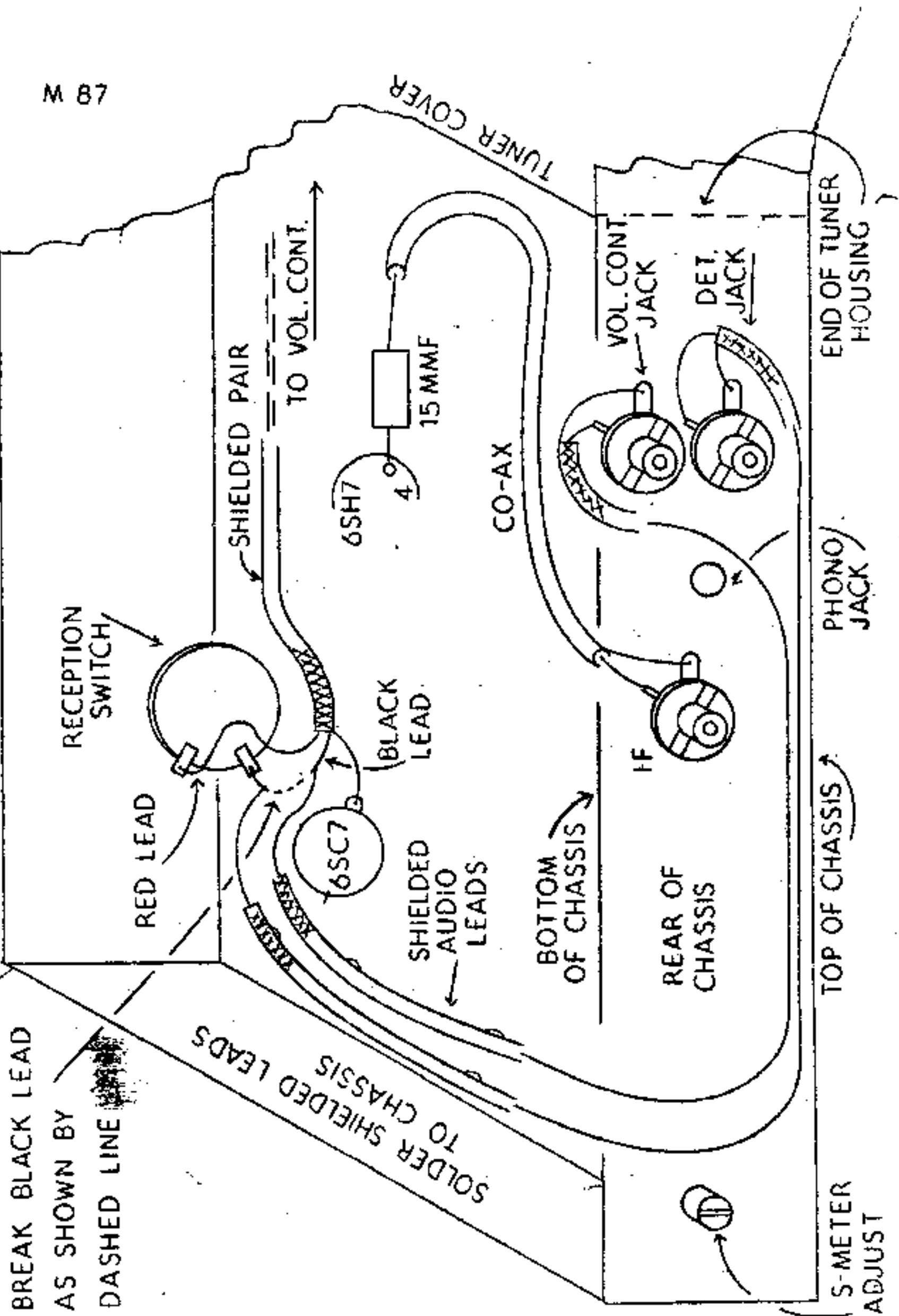

BREAK BLACK LEAD
 AS SHOWN BY
 DASHED LINE

SOLDER SHIELDED LEADS
 TO CHASSIS

USING THE SLICER WITH A
NATIONAL 101X RECEIVER

The 6C5 second detector must be changed to an audio amplifier by adding a 2200 ohm 1 watt resistor across R10, the second detector cathode bias resistor.

Remove the grid lead from pin #5 of the 6C5 and add a 100,000 ohm resistor from pin #5 to ground.

With the 101X, the AP-1 adapter is not required with the Model A or Model B Slicer.

For Model A Slicer, the coupling capacitor should be 50 to 75 mmfd. On Model B, only 15 mmfd. is required.

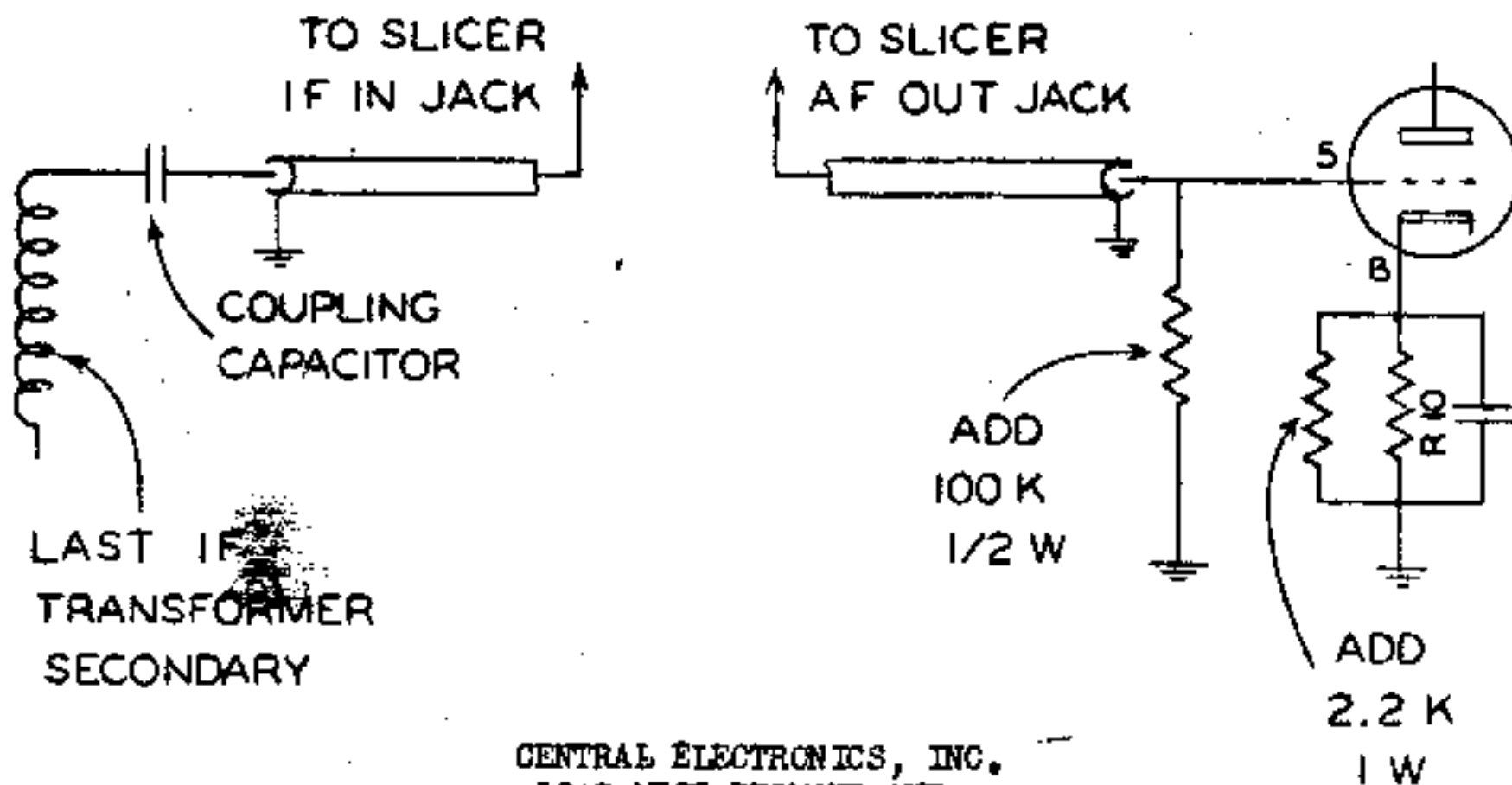

CENTRAL ELECTRONICS, INC.
1247 WEST BELMONT AVE.
CHICAGO 13, ILLINOIS

12-1-55
Model A & B Slicer

M-139
Page 13A

ALIGNMENT INSTRUCTIONS

MODEL A OR B

Allow about ten minutes warm up time.

Adjust receiver to minimum bandwidth without crystal filter.

The AVC and BFO should be OFF; the AF gain advanced. Minimum RF gain should be used at all times to prevent receiver overload.

With the sideband selector set to NORMAL, re-peak the receiver IF winding where the coaxial cable was connected for maximum signal or maximum noise output. On Model B, the "Q" Multiplier should be in the OFF position.

To align the IF transformer on the AP-1 adapter or "Q" multiplier, move the audio cable on the rear of the Slicer from the VOL CONT jack to the jack marked AF OUT. With the sideband selector on NORMAL align the IF trimmers on the AP-1 adapter or "Q" multiplier for maximum signal or noise output. Return the audio cable to the VOL CONT jack.

1. Tune the receiver to a spot where no signals are being received, then set the sideband selector switch to the BFO position. Noise background will be heard. Rock the oscillator frequency trimmer, C-1, (located behind the left 12AT7 tube) back and forth through its range. A point will be found where the noise output will be maximum. The oscillator must be adjusted to the exact center of the IF response curve. As the oscillator is detuned to either side of resonance, the noise output will "swish". The correct alignment frequency is the center of the two "swishes", where maximum noise results. This procedure is identical to tuning in an unmodulated carrier on the average receiver. The noise output should be equal in SIDEBAND 1 and SIDEBAND 2 when the oscillator is correctly centered on the IF peak.
2. Tune the receiver to an unmodulated carrier with the selector switch in the BFO position. Your frequency meter or VFO can provide the signal. Keep the RF gain well below the receiver overload point. Reset the selector switch to SIDEBAND 1. Detune the receiver until a beat note of approx. 1000 cycles is heard. Detune first on one side of zero beat and then on the other, leaving the receiver set to the weaker heterodyne. Adjust POT 1 for Maximum Rejection of this 1000 cycle heterodyne.
3. Detune the receiver to the other side of zero beat, switch to SIDEBAND 2 and adjust POT 2 for Maximum Rejection.

The rejection should be approximately equal in both sidebands and should average 40 db. (100:1 voltage ratio) over the range of 225 to 2750 cps measured at the output of the receiver audio system.

4. The following procedure should be used only if the rejection is unequal. It usually will not have to be adjusted by the user on factory built units. The kit builder will have to make this adjustment, however. In order to

Model A & B Slicer

6-1-55

Printed in USA

~~equalize sideband rejection~~, it may be necessary to adjust C13, the RF PHASE trimmer. The frequency of the beat note will change slightly as C13 is tuned. Reset the oscillator frequency trimmer to the original frequency. Readjust POTS 1 and 2 on their respective sidebands for maximum rejection, as in steps 2 and 3 above. Repeat steps 4, 2 and 3 until equal sideband suppression is obtained. Recheck frequency vs. noise setting of the oscillator as in step 1.

Regeneration in the receiver IF system may alter sideband symmetry. The frequency response of one sideband will not equal the other. Therefore it is desirable to remove all traces of regeneration.

ADJUSTING THE "Q" MULTIPLIER IN THE MODEL B SLICER

Switch the "Q" multiplier to PEAK and the sideband selector switch to EFO. Adjust the panel TUNING knob to "0". Turn the SELECTIVITY control fully clockwise to produce self-oscillation in the "Q" Multiplier. Adjust C103 (on the rear of the unit) for zero beat.

OPERATING INSTRUCTIONS

Due to a departure from conventional receiving methods, a period of familiarization will be necessary to tune signals with the Sideband Slicer. In general, operate the receiver with AVC off, RF Gain reduced and AF Gain increased to prevent receiver overload.

To receive AM or Narrow Band Phase Modulation it is necessary to zero beat the receiver carrier with the oscillator in the Slicer. Either sideband can be received at will without changing the receiver frequency. If interference exists in one sideband, receive on the other. Don't try to tune out interference, "switch" it out instead. When tuning across the band use the BFO position. It will be easier to zero beat the received carrier, then select the sideband with the least interference. Reception of an AM signal in the BFO position is not recommended due to phase distortion.

The Sideband Slicer supplies the carrier required to demodulate SSSC or SSB (Single Sideband) signals. It is convenient to tune across the band in the BFO position, then either upper or lower sideband SSB signals may be received. After the signal is tuned, switch to the desired sideband to listen in true single sideband fashion. If you try to tune in a lower sideband signal in the upper sideband position, the speech will be inverted.

Sideband suppression may be determined by switching sidebands on an SSB signal and listening to what remains on the unwanted side. A scope or a VTVM can be connected to the AUDIO OUTPUT jack on the front or rear of the unit to analyze the unwanted sideband.

To spot your own transmitter frequency, use the BFO position.

Use the BFO position to initially tune in the desired CW signal, then switch from one sideband to the other. The CW signal will not change on one sideband position, but will drop out on the other. You can make the CW signal reappear on that sideband by retuning the receiver. This time when you switch sidebands it will drop out on the sideband position where it was originally received. Of course the same treatment can be applied to interfering signals. By choosing the proper sideband and proper setting of the receiver dial, interference can usually be switched out.

The Xtal filter may be used in the normal manner to provide increased selectivity and a variable rejection notch in the desired sideband.

It is apparent that all signals higher in frequency than the Slicer oscillator will be received on one sideband position while those lower in frequency will be received on the other sideband position. SIDEBAND 1 will be the lower sideband if the receiver HF oscillator is higher in frequency than the received signal. If the HF oscillator is lower in frequency than the received signal SIDEBAND 1 will be the upper sideband. This relationship may change from band to band, depending upon the oscillator position with reference to the received signal.

To determine sideband relationship on your receiver, use your freq meter as a signal source. With the receiver set on SIDEBAND 1 at some convenient place in the band, tune the freq meter until a beat is heard. If the beat decreases in freq as you increase frequency on the freq. meter, SIDEBAND 1 is the lower sideband. If the beat increases, then SIDEBAND 1 is the upper sideband.

Do not expect the Sideband Slicer to cure a poor signal or an unstable receiver. For phone reception it is necessary to tune the recvr within 100 cycles, therefore it should have good bandspread. The recvr and the received signal should be free from frequency modulated hum, syllabic instability and rapid drift. Unstable signals may be received in the NORMAL position of the sideband selector.

Q MULTIPLIER

THEORY:

The "Q" Multiplier is a selectivity device for use with either the Sideband Slicer or any receiver having an IF frequency range from 450 to 500 Kcs. Model AQ is intended for use with Model A Sideband Slicer and converts the Slicer to Model E. Model DQ is a Desk Model for use with any receiver in the above IF frequency range.

The unit consists of a high "Q" coil connected in a vacuum tube (6AB4) circuit so that by means of feedback, the effective "Q" of the coil is multiplied many times. This results in a very high "Q" and a very high impedance at resonance. It may be used to increase the IF selectivity in the PEAK position, or else to put a "notch" in the IF passband in the NULL position.

Basically the unit has two separate signal paths; the "Q" channel consisting of the 6AB4 with the triode section of the 6U8, and the second channel consisting of the pentode section of the 6U8.

In the OFF position of the switch, the 6AB4 is disabled and the pentode section of the 6U8 is used as an IF amplifier. With this stage of amplification, the AP-1 is no longer required.

In the PEAK position the pentode functions as a grounded grid IF amplifier for the "Q" channel. With the SELECTIVITY control fully counter-clockwise, some selectivity is added at the frequency to which the "Q" circuit is tuned. Advancing the SELECTIVITY control increases the selectivity until the circuit goes into oscillation. At the point just before oscillation, the bandwidth is only a few cycles. This position is useful for CW, AM, FM and SSB, by using the proper amount of selectivity. Advancing the selectivity control too far on phone reception will result in loss of intelligibility due to the restricted bandwidth. Generally more selectivity can be used on strong and undistorted signals. If a strong heterodyne cannot be reduced sufficiently in the PEAK position, it will be necessary to switch to NULL.

In the NULL position both channels are used. The desired signal and the interfering carrier is applied between grid and cathode of the 6U8 pentode and to the "Q" Multiplier channel. Due to the high order of selectivity obtainable in the "Q" channel, the interfering carrier may be separated from the desired signal by tuning the "Q" circuit. This interfering carrier passes through the triode section of the 6U8 operating as a cathode follower and is cathode coupled to the pentode section. At this point the carrier from the "Q" channel is 180° out of phase, cancelling the interfering carrier in the signal channel.

In actual practice, when it is desired to null out an interfering carrier, proceed as follows:

Place the SELECTIVITY control at 50% rotation. Set the switch to NULL. Now tune to the interfering carrier with the TUNING control. The amplitude of the interfering carrier will decrease when the "Q" circuit is resonated. Maximum attenuation is achieved by carefully "rocking" both the SELECTIVITY and TUNING controls.

CAUTION: When attempting to remove an interfering carrier on an AM phone signal (with the receiver in NORMAL reception), be sure to tune the "Q" circuit to the interfering carrier and not to the carrier of the desired signal. Removing either one of the carriers will eliminate the heterodyne, but eliminating the desired carrier will result in severe distortion. This does not apply when the Slicer or BFO are used to reinsert carrier.

The built "Q" Multipliers are shipped using the 60 mmfd. section only on C104, the TUNING capacitor. With receivers utilizing a mechanical or lattice filter, or other extremely sharp IF system, the stator lead should be changed over to the 30 mmfd. section (3 plates) to obtain greater TUNING bandspread. When older receivers are used which have an IF passband of 20 to 25 kilocycles, both sections of C104 should be wired in parallel in order to cover this range.

SIMPLIFIED "Q" MULTIPLIER SCHEMATIC

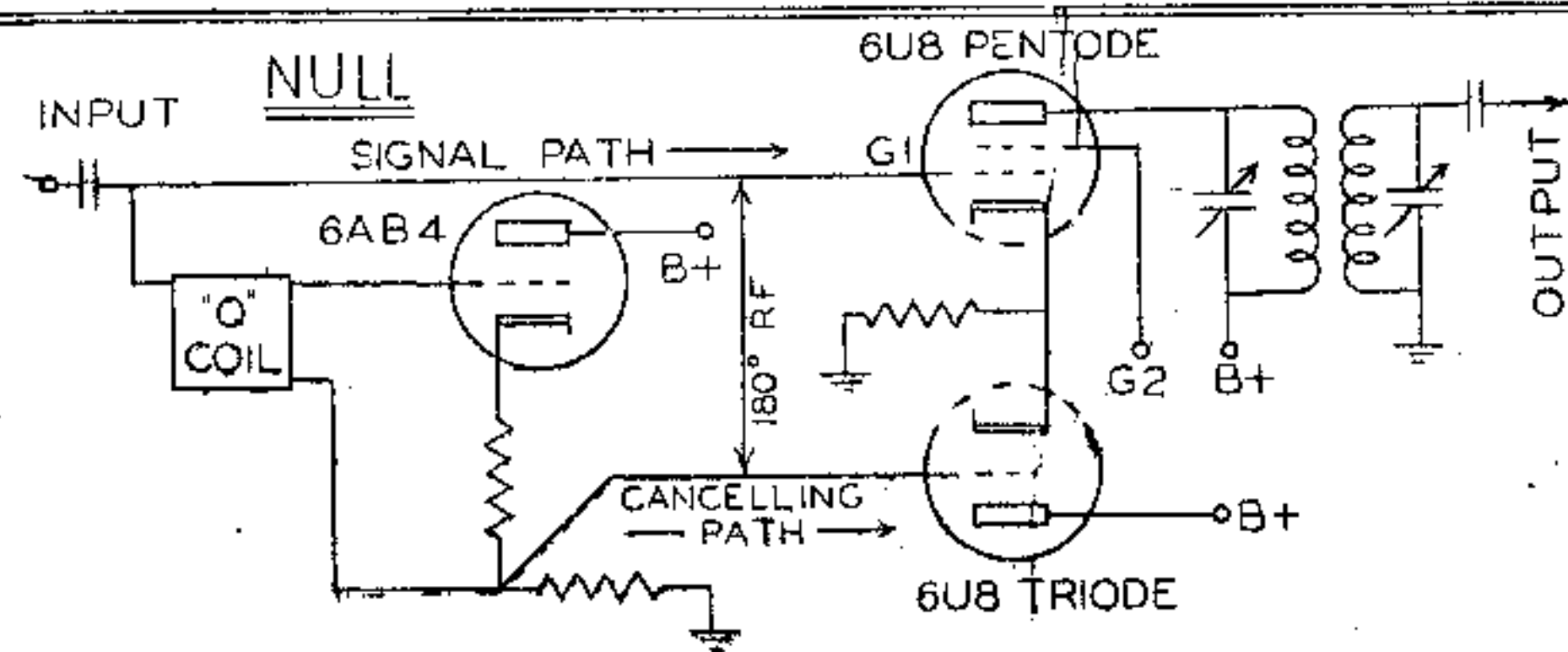
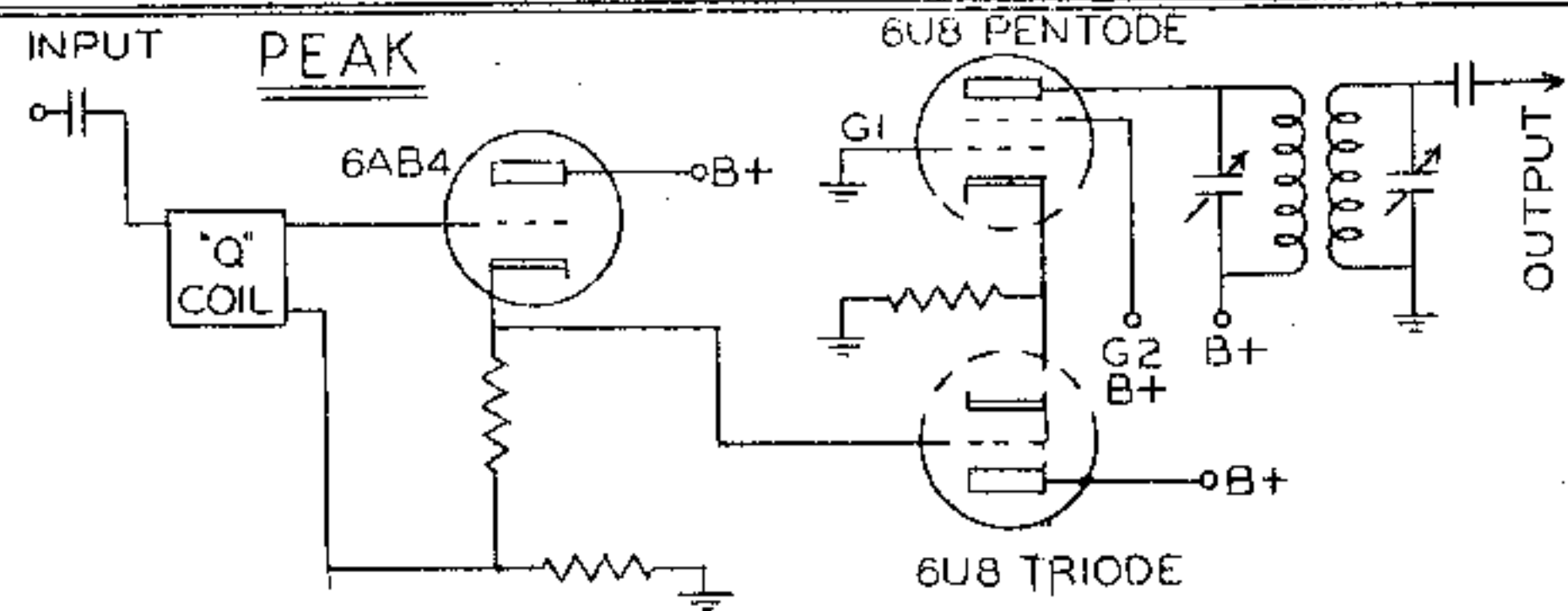
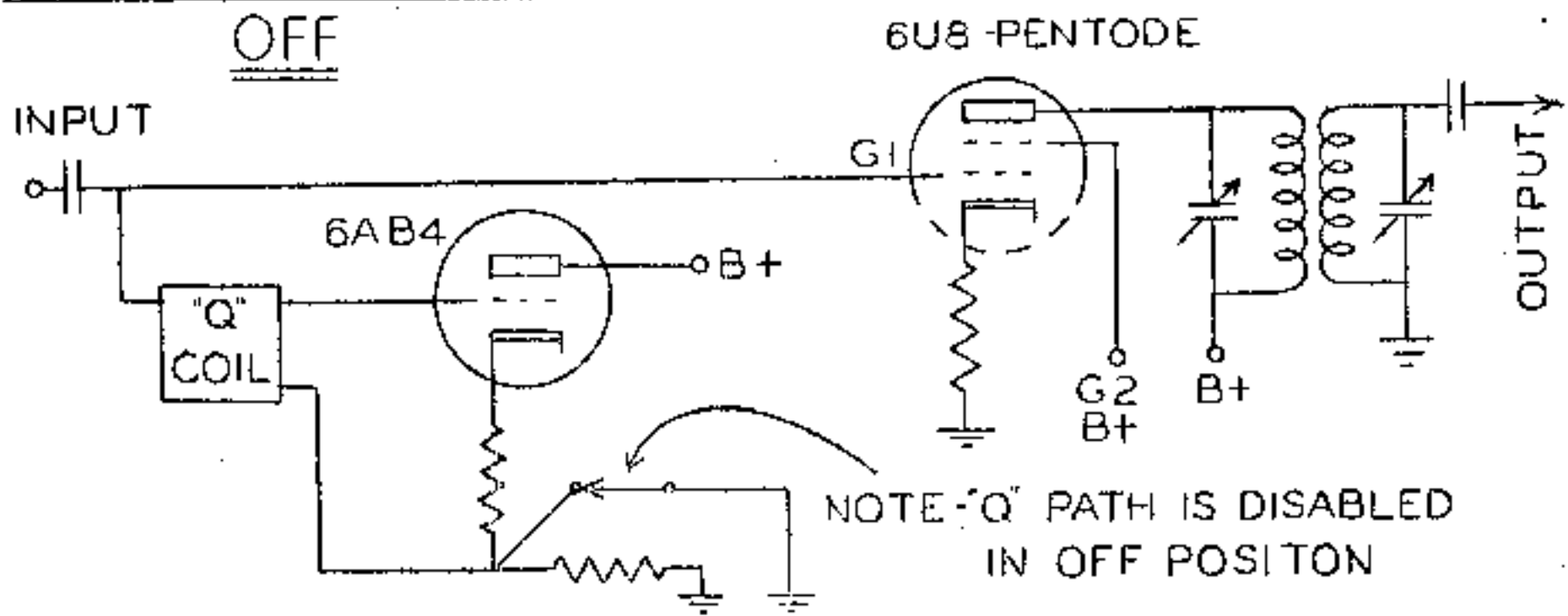

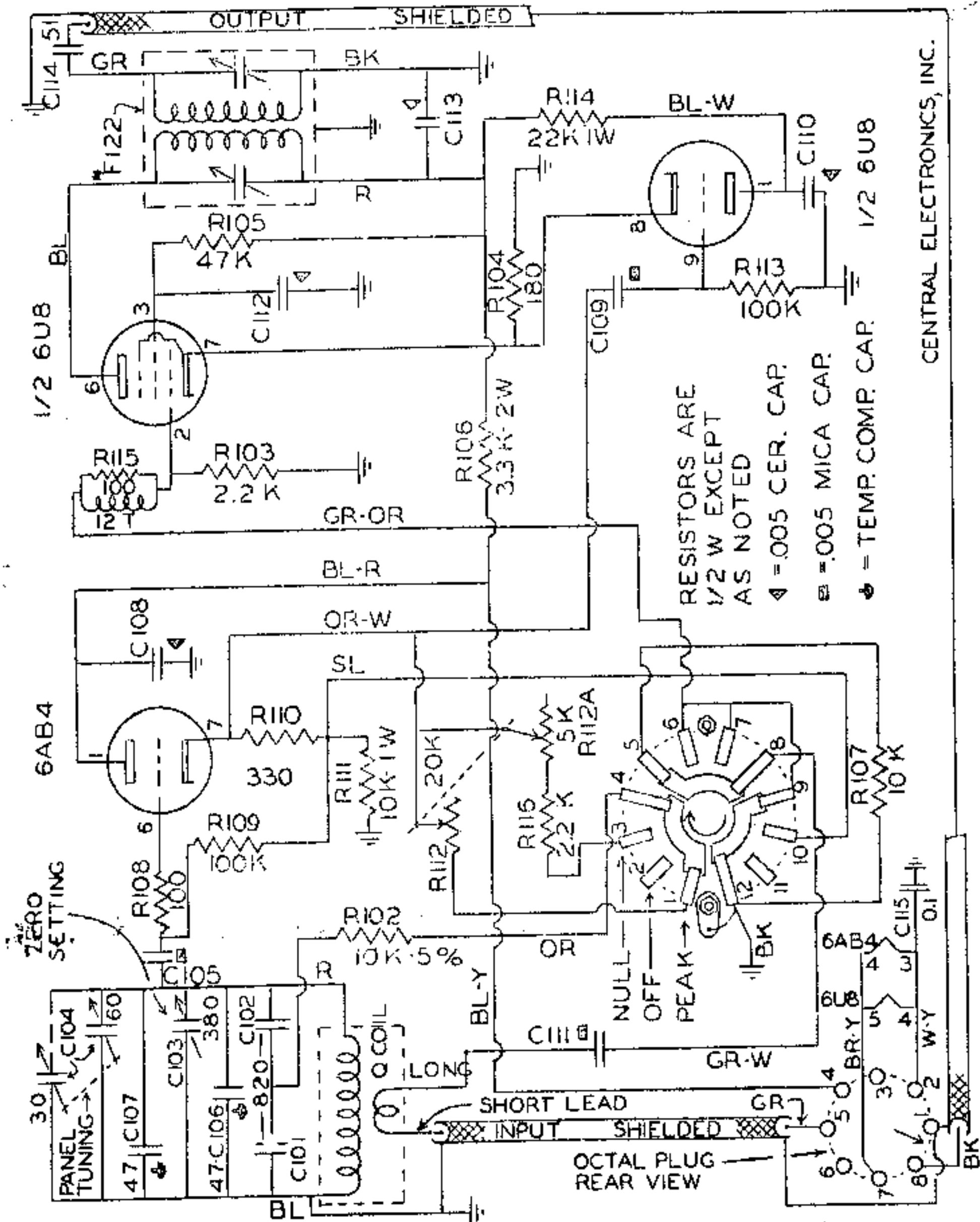

SCHMATIC Q MULTIPLIER

FIG. 1

③

M131A

CENTRAL ELECTRONICS, INC.

Q MULTIPLIER
DC VOLTAGES

SELECTIVITY CONTROL FULLY CCW EXCEPT LAST COLUMN

DC VOLTS

TUBE	PIN NO.		OFF	PEAK	NULL	OSC PEAK
6AB4	1	PLATE	235	235	235	235
"	6	GRID	0	46	46	50
"	7	CATHODE	2.4	52	52	56
6UB	1	PLATE TRIODE	112	112	112	
"	2	GRID #1 PENTODE	0	0	0	
"	3	GRID #2 "	108	108	108	104
"	6	PLATE "	200	200	200	200
"	7	CATHODE "	2.05	2.05	2.05	2.05
"	8	" TRIODE	"	"	"	"
"	9	GRID "	0	0	0	-10 TO -32 *

* DEPENDING ON HOW FAR PAST OSCILLATION POINT POTENTIOMETER IS SET.

POWERED FROM SLICER AT 117 V. LINE. SLICER HAS B+ TO ACCESSORY SOCKETS BEFORE 1800 Ω RESISTOR.

READINGS TAKEN WITH VTVM, MINUS TO CHASSIS, EXCEPT *

1/2 12AT7 (A)

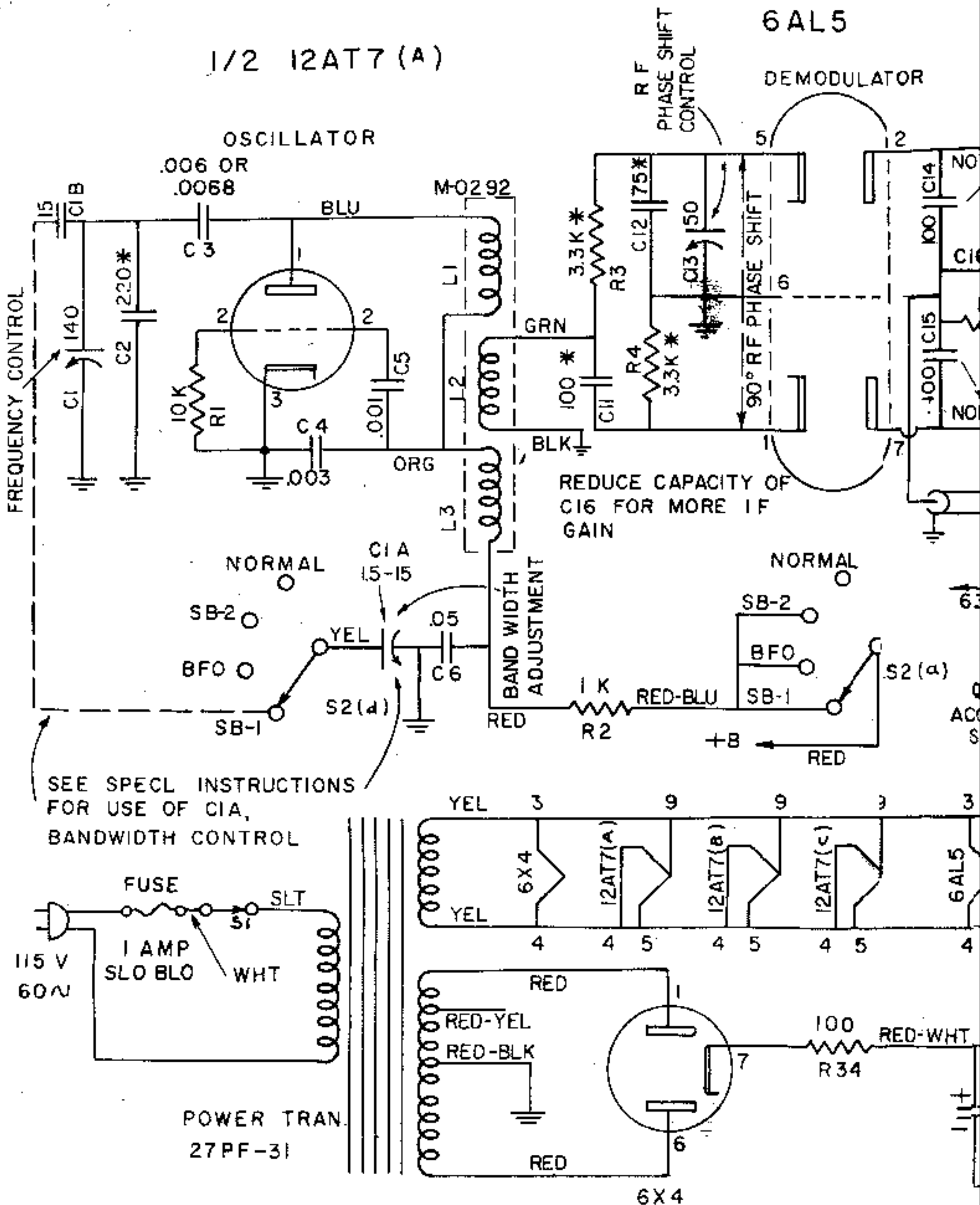

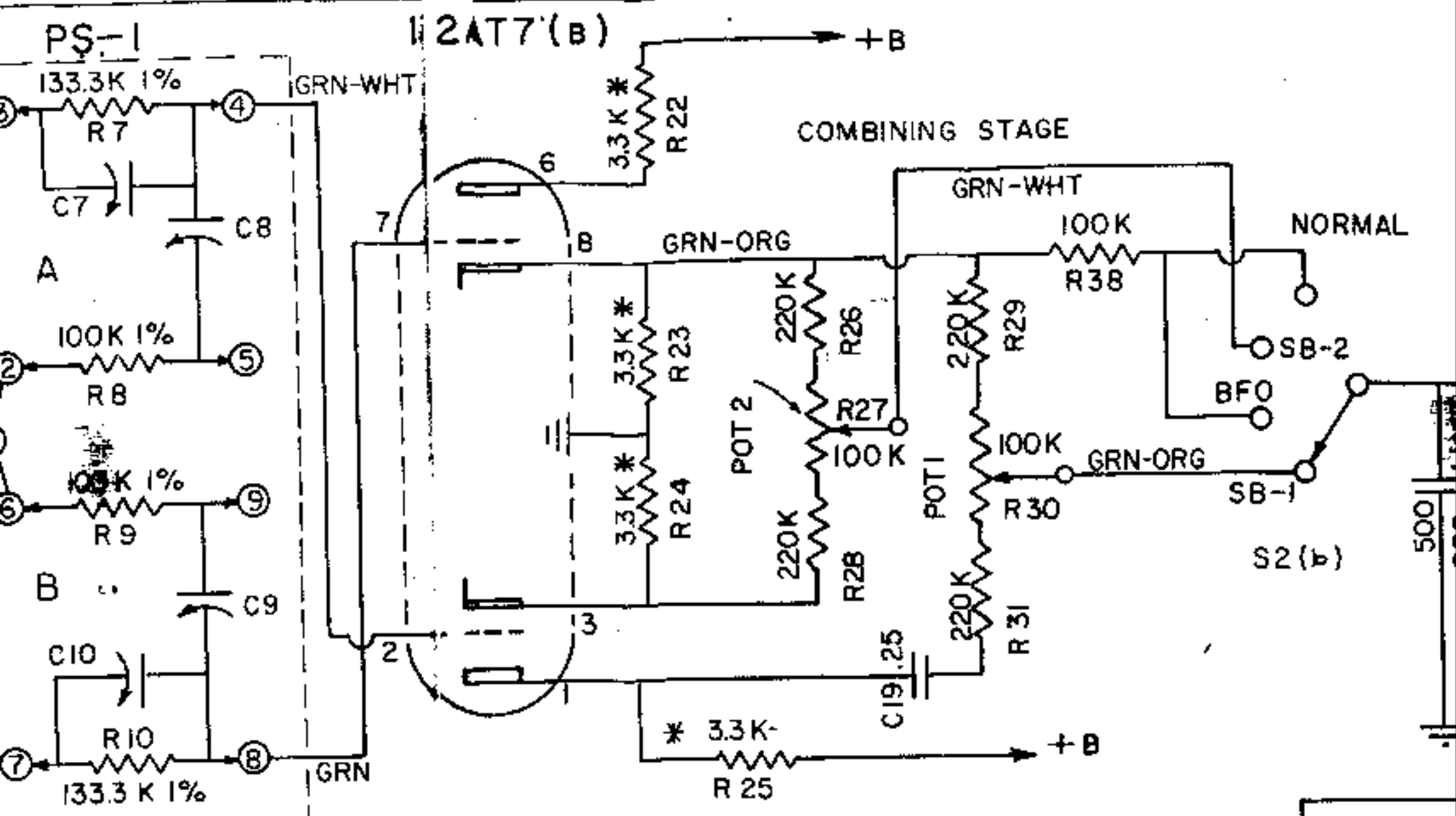

NUMBERS 1 TO 9
PLUG-IN PS-1
NET NETWORK

- NOTES
1. C14 B C15 ARE MATCHED WITHIN 5%
 2. ALL RESISTORS ARE 10%-1/2 WATT EXCEPT AS NOTED. K=1000 OHMS.
 3. ALL CAPACITORS ARE 20% EXCEPT AS NOTED.

* = 5%

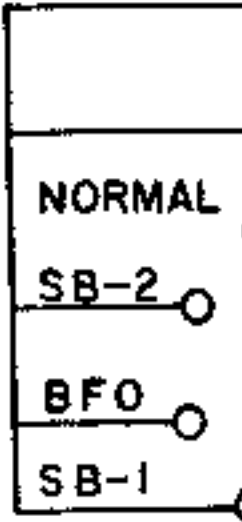

ALL SWITCH SHORTING

RF VOLTAGES ARE PEAK
ALL VOLTAGES MEASURED WITH VTVM

PIN	1	2	3	4	5	6	7	8	9
12AT7 (A)	245V	-15V		FIL	FIL	120V	14V	15V	FIL
OSC	DC	DC				DC	DC	DC	
AUDIO	135V	17V							
	RF	RF							
12AT7 (B)	235V	10.5	13.5	FIL	FIL	235	10.5	13.5	FIL
12AT7 (C)	215V	6.8	10.5	"	"	215	6.8	10.5	"
PH. INV.									
6AL5	+1V	-25	FIL	FIL	+1V	---	-25		
DEM. MOD.	DC	DC			DC		DC		
	25V				25V				
	RF				RF				
6X4	245V		"	"		245V	300V		
RECTIFIER	AC					AC	DC		
	60Ω					60Ω			

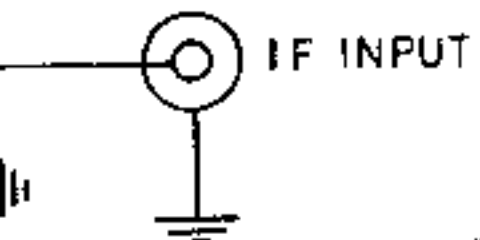

AP-1, AP-2
ADAPTER
SOCKET

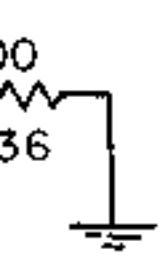

V

1/2 12AT7 (A)

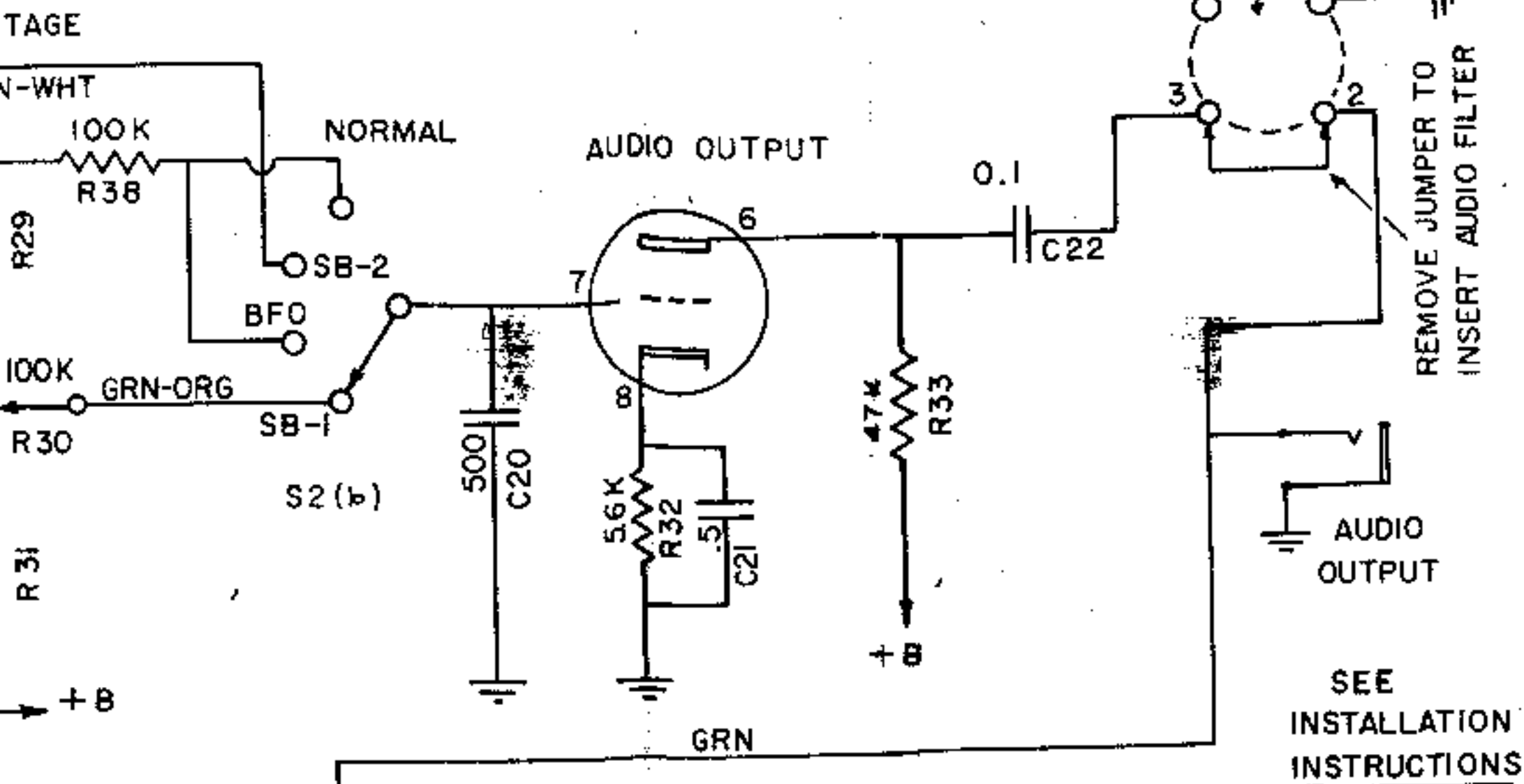

SEE INSTALLATION INSTRUCTIONS

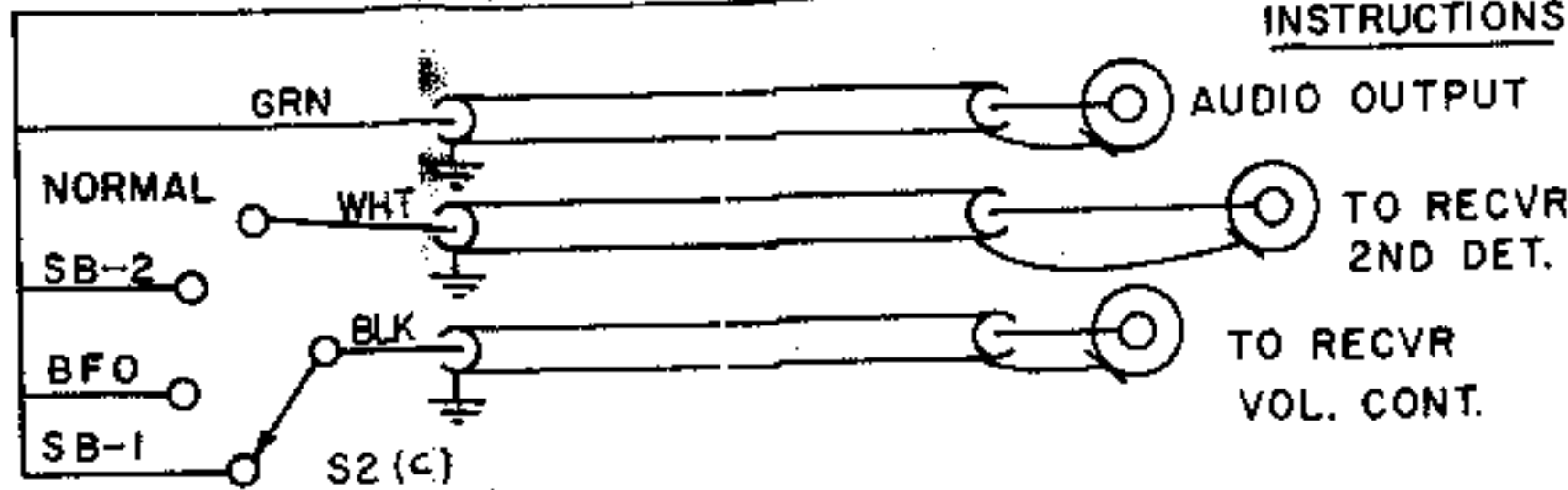

SCHMATIC

ALL SWITCH WIPERS ARE SHORTING TYPE

DR. NO. 55-206
 DRG NO Z300
 1-7-55. 5-9-55.

* = 5%

7	8	9
4V	15V	FIL
DC	DC	
0.5	13.5	FIL
0.8	10.5	"
25		
DC		
100V		
DC		

CENTRAL ELECTRONICS, INC.
 1247 BELMONT AVE.
 CHICAGO, 13, ILL.

SIDEBAND SLICER MODEL A-B
 FOR SERIAL NO. 5700 & UP